

Company Profile

Shandong HonHai Industrial Co. Ltd.

We started to produce neutral pharmaceutical glass tube from the year 1998, and become the leading manufacture in China of this important raw material for tubular glass containers. In the following years, we rapidly expanded our business to nearly cover all pharmaceutical glass package. Now we make or supply the follow items.

- Neutral pharmaceutical glass tube UPS TYPE I
(COE 5.0 & COE 7.0)
- Tubular glass vial and ampoule
- Moulded injection glass vial
- Moulded infusion glass bottle
- USP TYPE I glass
- Cartridge & prefillable syringe
- Blood collect tube
- Glass dropper
- Butyl rubber stopper
- Aluminum plastic cap

As one of the leading manufacture of pharmaceutical glass package in China, we strive to upgrade our quality level with a continuous pace to satisfy, even lead the market demand. We enjoys a good reputation in South East Asian market, South Korea, Middle east, Latin America and some European countries except for Chinese market.

We will improve, upgrade and innovate products all the time.



Neutral Pharmaceutical Glass Tubing -USP TYPE I

SFDA STANDARD: COE 7.0

Physical Property

No.	Physical Performance	Numerical Value	Unit
1	coefficient of mean linear thermal expansion(20°C ,300°C)	7.0±0.1	10 ⁻⁶ K ⁻¹
2	Transformation temperature	550±15	°C
3	Softening point	750±10	°C
4	Working point	1110±20	°C
5	Density at 20°C	2.46±0.02	g/cm ³



Main Composition

SiO ₂	B ₂ O ₃	Na ₂ O	BaO	CaO	Al ₂ O ₃
70	6.6	11	<2	<3	6.2

Chemical Property

Water resistance to ISO720	1
Water resistance to European Pharmacopoeia	1
Water resistance to USP23	1
Acid resistance Class(DIN12116)	1
Alkali resistance Class(ISO695)	2



Tubing Size for Ampoule (mm)

OD		Wall Thickness		Length		Straightness	
Basic Size	Tolerance	Basic Size	Tolerance	Basic Size	Tolerance	Measuring distance	t _≤
9.50	±0.20	0.45	±0.03	700-2000	±6.00	1000	2.5‰
10.00							
11.25		0.50					
11.50							
14.25	±0.24	0.52	±0.04				
16.00	±0.24	0.55					
16.25	±0.26	0.64					
18.40	±0.30	0.60					
22.00		0.70					

We also can manufacture customized sizes.

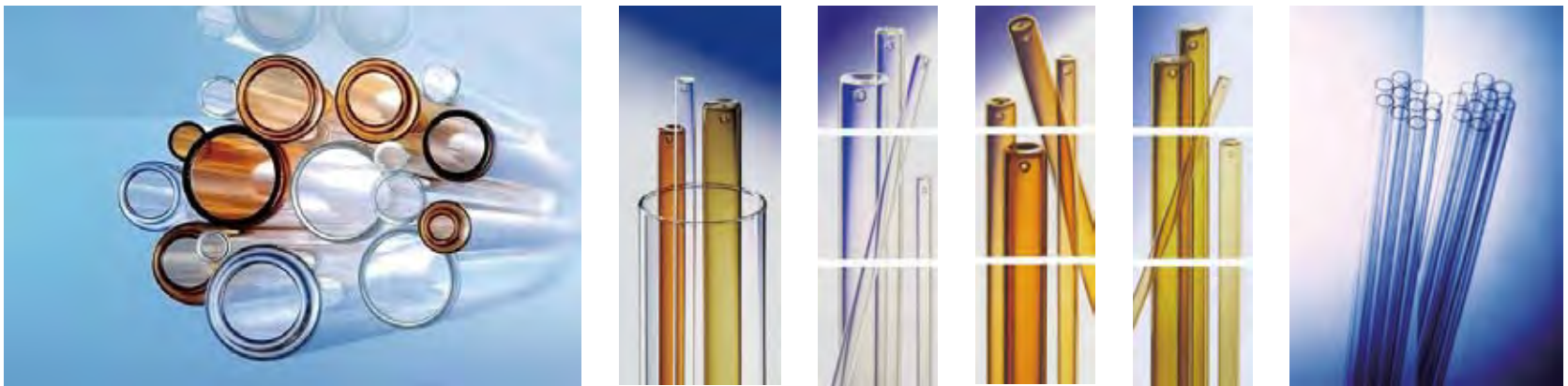

Tubing Size for Vial (mm)

OD		Wall Thickness		Length		Straightness	
Basic Size	Tolerance	Basic Size	Tolerance	Basic Size	Tolerance	Measuring distance	t _≤
16.00	±0.26	0.80	±0.05	1000-2000	±6.00	1000	2.5‰
16.25	±0.28	0.80					
18.40	±0.30	0.80					
22.00	±0.35	0.90	±0.07				
28.00	±0.35	1.00					
		1.20					

We also can manufacture customized sizes.

Neutral Pharmaceutical Glass Tubing -USP TYPE I

ISO STANDARD: COE 5.0

PHYSICAL DATA

Coefficient of mean linear thermal expansion

$\alpha(20^{\circ}\text{C};300^{\circ}\text{C})$ acc to ISO 7991 $5.5 \cdot 10^{-6} \text{ K}^{-1}$

Transformation temperature T_g 540°C

Glass temperature at viscosity η in $\text{dPa} \cdot \text{s}$

10^{13} (annealing point) 545°C

$10^{7.6}$ (softening point) 750°C

10^4 (working point) 1110°C

Density ρ at 25°C $2.36 \text{ g}\cdot\text{cm}^3$

CHEMICAL DATA

Hydrolytic resistance

Acc. to ISO 719 Class HGB1

Acc. to C-Ph. Eur Type I

Acc. to C-USP Type I

Acc. to C-JP Type I

USP extractable arsenic $<0,01$ ppm

CHEMICAL COMPOSITION

SiO₂ B₂O₃ Al₂O₃ Na₂O K₂O BaO CaO

73 10 6 7 1 2 1

TRANSMISSION

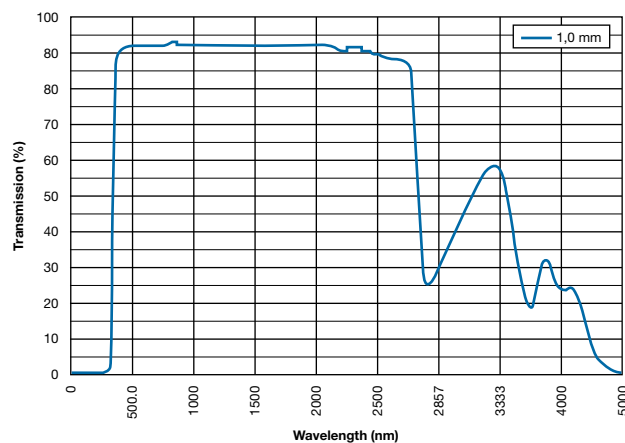

Tubular Glass Vial

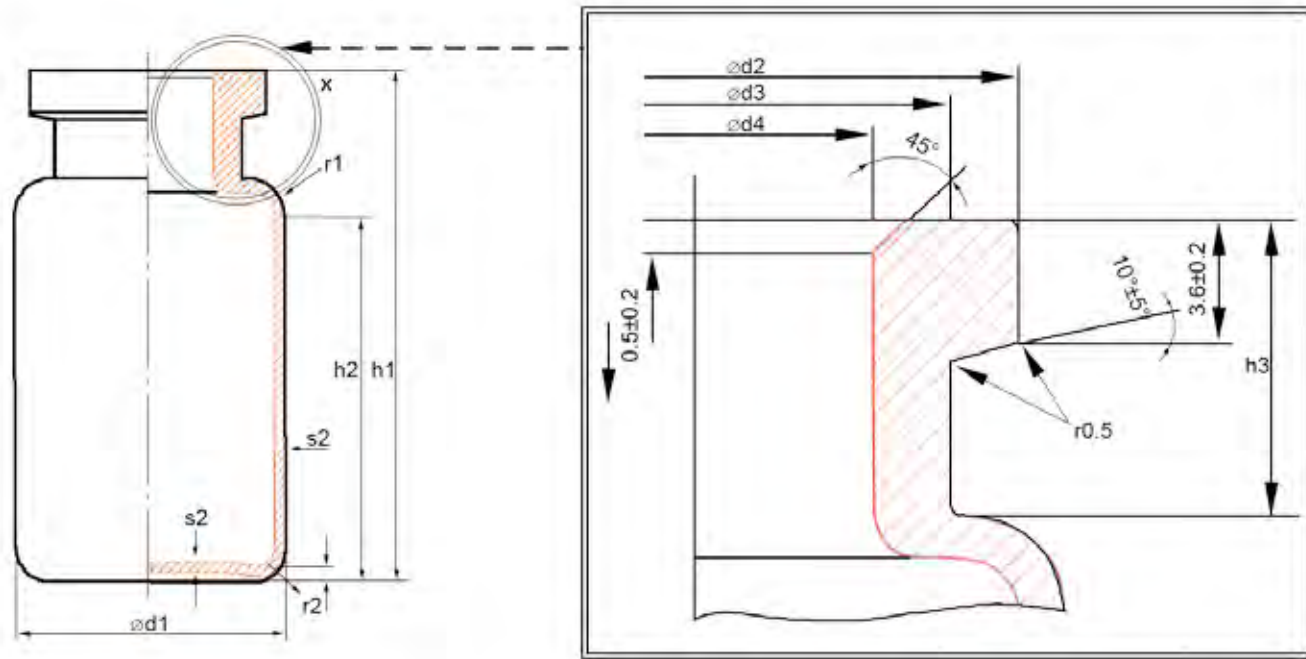

Capacity	Max.Vol. (ml)		a	d1		d2	d3	d4	h1		h2		h3		r1	r2	s1	s2	t	N.W		
		Tolerance		Tolerance	+0.2 -0.3	Max	Tolerance	Min	Tolerance	Min	Tolerance	≈	≈			in	Max	g≈				
2R	4.0	±0.5	1.0	16.0	±0.2	13.0	10.5	7.0	±0.5	23.0	8.0	±0.5	2.5	1.5	3.5	2.0	1.0	±0.04	0.7	0.7	5.0	
4R	6.0																				45.0	33.0
6R	10.0		40.0	27.0		8.5	8.3															
8R	11.5		45.0	32.0		9.0	9.4															
10R	13.5	±1.0	1.2	24.0	20.0	16.5	12.6	60.0	±0.5	31.0	9.0	±0.5	3.5	2.0	1.0	±0.04	0.7	0.7	0.7	10.2		
15R	19.0																			46.0	46.0	12.8
20R	25.0	±1.5	1.5	30.0	±0.3	17.5		55.0	±0.7	35.0	10.0	±0.75	5.5	2.5	1.2	±0.05	1.0	1.0	1.0	17.4		
25R	30.5																			46.0	46.0	20.0
30R	36.0																			75.0	55.0	22.7

We also make it to your customized dimensions.

Plain Tubular Glass Vial



Screw Neck Glass Vial

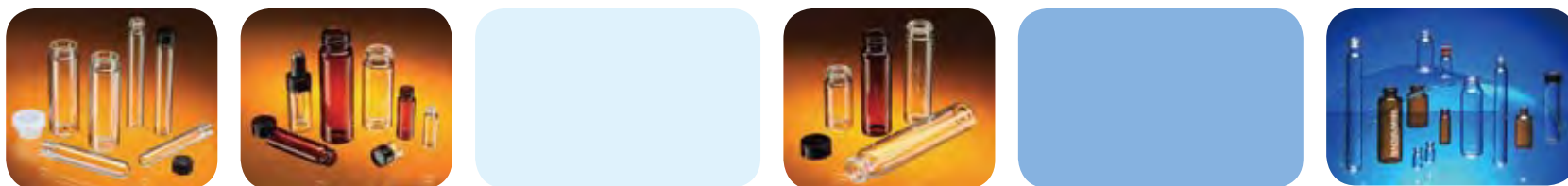

Tubular Perfume Glass Vial



Test Tube

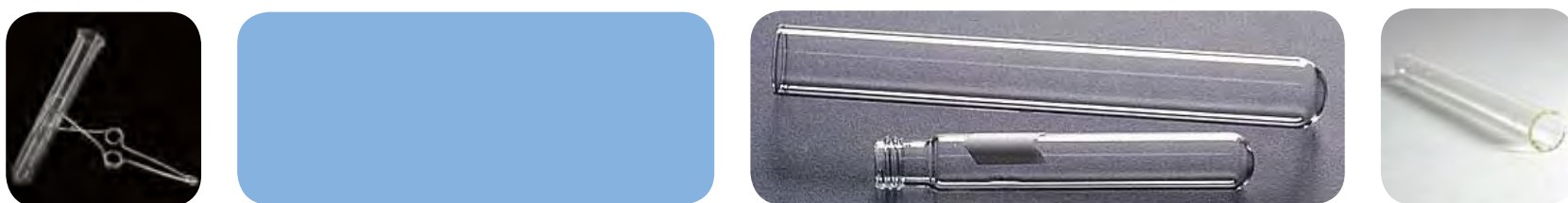

Tubular Glass Ampoule

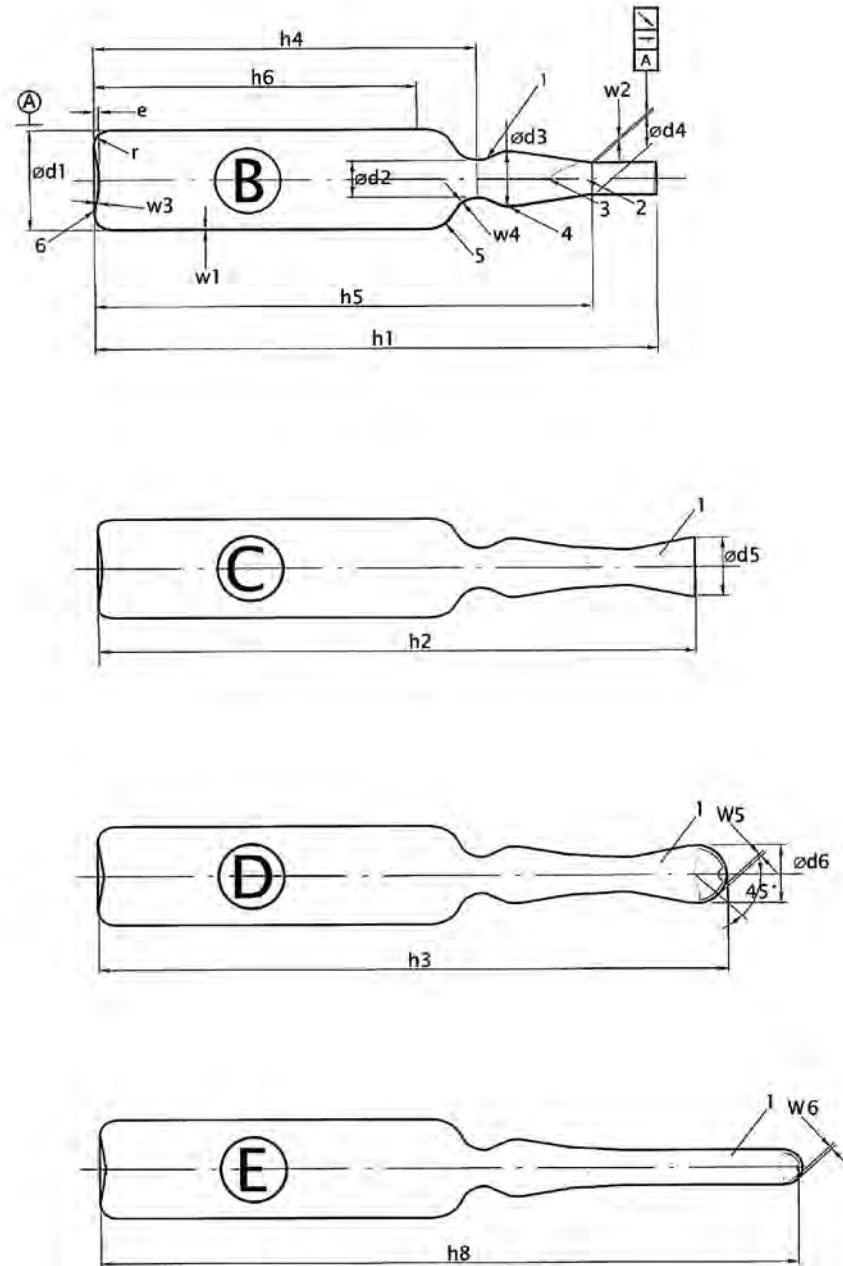

Capacity (ml)	Outer Diameter										Total height			
	Body		Constriction	Bulb		Stem		Fume		Sphere	Type B	Type C	Type D	Type E
	d1		d2		d3		d4		d5	d6	h1	h2	h3	h8
		Tolerance	±0.5		Tolerance		Tolerance		Tolerance	±1.0c	±1.0	±1.0	±1.0	±1.0
1	10.75	±0.15	6.5	8.5	±0.5	6.0	±0.35	9.0	±0.8	10.0	60.0	67.0	70.0	86.0
2	10.75	±0.15	6.5	8.5	±0.5	6.0	±0.35	9.0	±0.8	10.0	72.0	79.0	83.0	98.0
3	12.75	±0.15	6.5	8.5	±0.5	6.0	±0.35	10.7	±0.8	10.5	75.0	82.0	89.0	100.0
5	14.75	±0.15	7.0	9.0	±0.5	7.0	±0.35	12.2	±1.0	12.0	83.0	90.0	95.0	105.0
10	17.75	±0.20	7.5	9.5	±0.5	7.1	±0.35	13.0	±1.0	13.5	102.0	109.0	112.0	123.0
20	22.5	±0.25	8.5	12.0	±1.0	7.8	±0.5	14.0	±1.0	13.5	113.0	120.0	126.0	145.0
25	22.5	±0.25	8.5	12.0	±1.0	7.8	±0.5	14.0	±1.0	13.5	128.0	135.0	141.0	160.0
30	22.5	±0.25	8.5	12.0	±1.0	7.8	±0.5	14.0	±1.0	13.5	143.0	150.0	156.0	175.0

Height			Base			Wall Thickness									
Height Up to Constriction	Height Up To Gauging Point	Body Height	Base Radius	Depth of the base		Of Body		Of Gauging point	Depth of the base	Thickness		Sphere thickness		Eccentric Tolerance	
h4	h5	h6	r	e		w1		w2	w3	w4		w5	w6	t	
Tolerance	±2.0	Min	±0.5	Tolerance		Tolerance		±0.05	Min	Tolerance					
25.5	±0.5	47.0	21.0	1.0	±0.5	0.5	±0.03	0.37	0.3	0.7	±0.1	0.1	0.2	0.6	
37.5	±0.5	57.0	33.0			0.5	±0.03	0.37	0.3					0.6	
39.5	±0.5	62.0	35.0	1.5	±0.5	0.5	±0.03	0.37	0.3	0.7	±0.15	0.25	0.4	0.8	
46.5	±0.5	68.0	41.0			0.55	±0.03	0.4	0.4					1.0	
62.0	±1.0	87.0	55.0	2.0	1.25	±0.75	0.6	±0.04	0.47	0.4	0.8	±0.15		1.0	
76.0	±1.3	100.0	65.0	2.5	1.5	±1.0	0.7	±0.04	0.5	0.5	1.0	±0.2	0.1	0.2	1.2
91.0	±1.3	115.0	80.0				0.7	±0.04	0.5	0.5					1.2
106.0	±1.3	130.0	95.0				0.7	±0.04	0.5	0.5					1.2



Moulded Injection Glass Vial



Product Standard: ISO and SFDA (China National Standard)

Color: clear and amber

Standard specifications:

Capacity (ml)	Overall height (mm)	Body Diameter (mm)	Outer Diameter of Mouth (mm)
7	40.8	22.1	20
8	46.8	23.0	20
10	53.5	25.4	20
15	58.8	26.5	20
20	58.0	32.0	20
30	62.8	36.0	20
50	73.0	42.5	20
100	94.5	51.6	20

Infusion Bottle



Product Standard: ISO and SFDA (China National Standard)







Color: clear and amber

Standard specifications:

Standard	Capacity (ml)	Overall height (mm)	Body Diameter (mm)	Outer Diameter of Mouth (mm)
ISO	50	68	46	32
ISO	100	104	49	32
ISO	250	136	66	32
ISO	500	177	78	32
SFDA	50	78	46	28.3
SFDA	100	110	53	28.3

USP TYPE I Glass



 ml	 ml		 g	 mm	 mm
20	26	ISO/SFDA	29.0	58.0	32.0
30	38	ISO/SFDA	35.0	62.8	36.0
50	60	ISO/SFDA	50.0	73.0	42.5
50	68	ISO 32	60.0	68.0	46.0
100	119	ISO/SFDA	89.0	94.5	51.6
100	128	ISO 32	100	104	49.0
150	213	39.5	155	120	65.0
250	303	39.8	210	157.5	66.0

Cartridge



ml	mm	mm	mm
1.5	8.65	6.85	56.95
1.8	8.65	6.85	62.00
3.0	11.60	9.70	62.30
3.0	11.60	9.65	62.30



Material:

Type I glass (EP/USP/JP compliant)

- Sizes from 1 to 10 ml, other sizes on request
- Packaging options: PP-box, tray, shrink wrap
- Suited to standard filling and packaging equipment
- Customized ceramic printing with heavy-metal-free inks
- Optional: special treatment with ammonium sulphate for greater surface resistance
- Cartridges (ISO or customised) to be used for pen systems, auto- or needle free injectors

Prefillable Syringe



		
0.5 ml 27G 1/2''	47.6	6.85
1.0ML 27G 1/2'' Long	54.0	8.15
1.0ml 25G 5/8''	35.7	10.85
1.5ml 27G 1/2''	43.0	10.85
2.25ml 27G 1/2''	54.4	10.85
3ml 27G 1/2''	72.2	10.85
5ml 27G 1/2''	66.7	14.45

Material:

Type 1 glass (EP/USP/JP compliant),
plunger rod PP, PS

- Drug Master File Type III
- Suited to standard filling and packaging equipment
- Customised ceramic printing with heavy-metal-free inks
- Optional: special treatment with ammonium sulphate for greater surface resistance
- Other rubber formulations on request

Needle shields and stoppers in various rubber formulations and designs are available on request. Rigid needle shields (Stelmi® 4800, Gerresheimer RNS/TPE - thermoplastic elastomer) are also available.

Blood Collect Tube

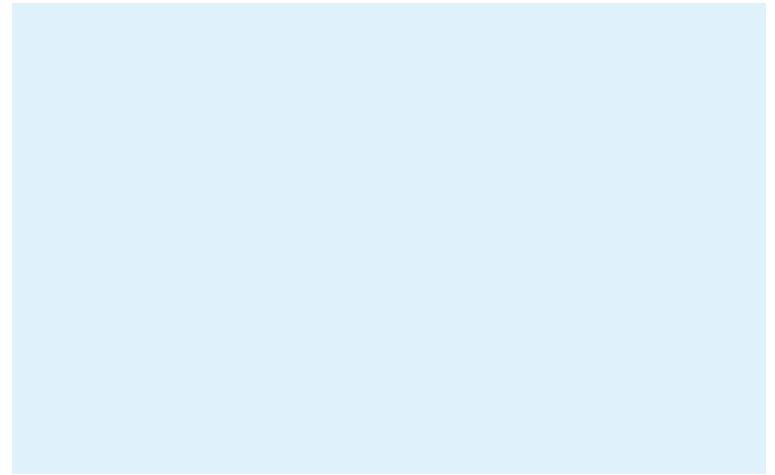

Specification:

Whole blood tube: EDTAK2 Tube, EDTAK3 Tube.

Serum tube: plain tube with clot activator, plain tube without additive, SSGT tube, thrombin tube.

Plasma tube: PSGT tube, EPGT tube, ESR tube, glucose tube, coagulation tube, sodium heparin tube, lithium heparin tube, coagulation tube with sandwich.

Glass Dropper

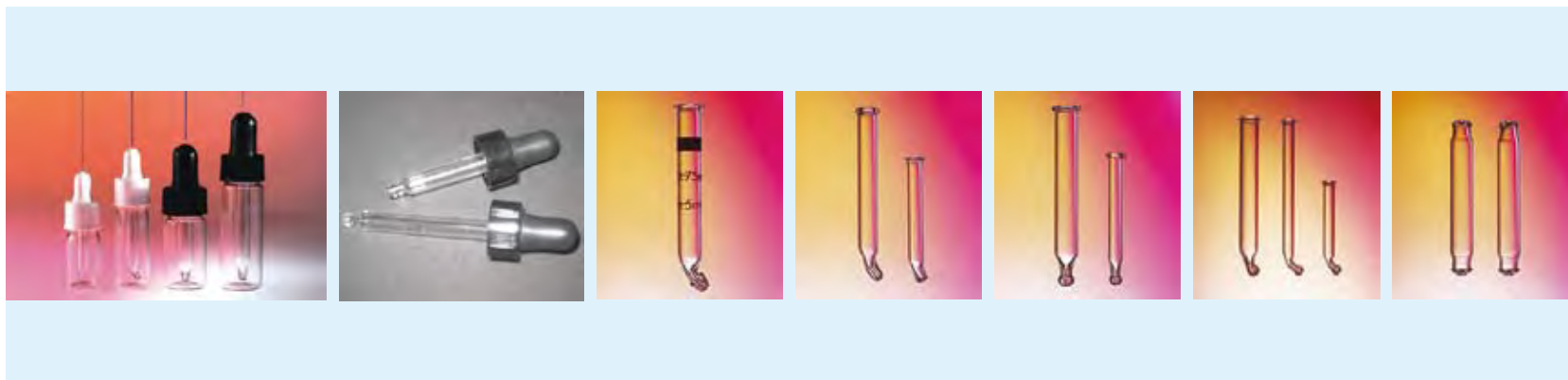

Specification

Glass dropper

1. tip:straight ,bent ball, blunt
2. diameter:5mm-9mm
3. length :<50mm,50~70mm,70~100mm
4. print

item	packaging	Carton measure	G/N Weight
Dia(5mm,6mm,7.25mm) Length(50-70mm) straight tip	1000pcs/paper box 6 paper box/Carton	48*39*24cm	14/13.5kg
Dia(5mm,6mm,7.25mm) Length(50-70mm) blunt tip	1000pcs/paper box 6 paper box/Carton	48*39*24cm	14/13.5kg
Dia(5mm,6mm,7.25mm) Length(50-70mm) bent tip	1000pcs/paper box 6 paper box/Carton	48*39*24cm	14/13.5kg
Dia(8.5mm) Length(50-70mm) straight tip	1000pcs/paper box 6 paper box/Carton	48.5*39.5*24cm	15/14.3kg
Dia(8.5mm) Length(50-70mm) blunt tip	1000pcs/paper box 6 paper box/Carton	48.5*39.5*24cm	15/14.3kg
Dia(8.5mm) Length(50-70mm) bent tip	1000pcs/paper box 6 paper box/Carton	48.5*39.5*24cm	15/14.3kg

Butyl rubber stopper



Product description:

We can produce any sizes according to request.

Normal color: gray.

Minimum order quantity is 500,000pcs.

Standard: ISO and YBB.

Quality control:

Whole course controlled by ISO9001:2000, ISO14001:2004, OHSAS18001:1999 standard.

Workshop: clean modern workshop.

Butyl Rubber Stoppers for Injection Vials;

Butyl Rubber Lyophilous Stoppers;

Butyl Rubber Stoppers for Infusion Bottles;

Butyl Rubber Hemostix Stoppers;

Butyl Rubber Hemostix Stoppers;

Rubber Plungers for Asepsis Disposable Syringe;

Aluminum plastic cap



Specifications

flip off cap:

Standard: ISO and YBB.

All types of flip off caps according to drawing.

13mm, 20mm, 28mm, 32mm.

flip off cap:

Standard: ISO and YBB.

We can produce all type of flip off caps according to drawing.

Normal sizes: 13mm, 20mm, 28mm, 32mm.

